

Burns and Ferrall Locations

AUCKLAND
 12 Reg Savory Place
 East Tamaki, Auckland

0800 697 465

WELLINGTON
 122-124 Tory Street
 Te Aro

HAMILTON
 60 Alexandra Street
 Central

CHRISTCHURCH
 345 St Asaph Street
 Christchurch

Product Specification Sheet
BFD540R10

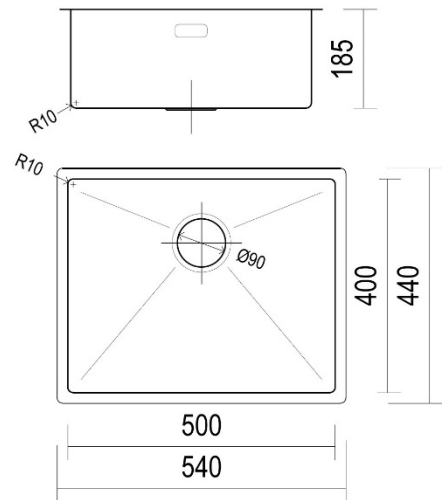

Designer R10
B&F Designer R10 500 Single Bowl

Models	Corner Radius
14 BFD540R10	10mm
Overall Dimensions W x D	Waste
540 x 440mm	90mm
Bowl Dimensions W x D x H	Installation
500 x 400 x 210mm	Top / Flush / Undermount
Material & Finish	Minimum Cabinet Size
1.2mm 304 Stainless Steel, Silky Sheen	620mm

Accessories Available (optional)



E&OE – it is recommended all measurements are taken directly from the product. Specification subject to change without notice, always consult the literature supplied with the product. Coloured images are indicative only.